



HARBOR AREA MODEL 'A' CLUB

Dedicated to preserving and driving the 1928-1931 Model 'A' Ford since 1957
Torrance, California

SEPTEMBER 2024

2016-2022 MARC
Award of Continuing Excellence
for Harbor Light newsletter.
2020, 2023 MAFCA
Newsletter of Merit



15 Harbor Club Model A's lined-up at the annual Harbor Area picnic in Lomita, CA.

Technical Activities

Saturday mornings.
We meet from about 9:30AM to noon to work on Model A projects. Bring your Model A by and we'll work on it.
Al's Garage,
907 Van Ness, Torrance CA
(in the alley)

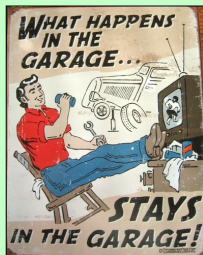

Next Club Meetings:

The August meeting was at the annual picnic.
The September meeting is at the Waleria Clubhouse on Friday, September 27th, 7:30PM

Next Board Meeting

The next Board meeting will be Saturday, September 7th at Al's garage, 9:30AM



inside

- 2 Dennis' Words — Artist efforts
- 2 Editor's Corner — It's show time!
- 3 July Business mtg notes
- 4 Club merchandise - Items for sale
- 4 Local 1940 Manhattan Beach pic
- 5 Tour to Lion's Car Museum
- 6 Upcoming events calendar
- 7 Annual picnic pics

- 8 Technical tip— Front spring perch removal
- 9 Birthday and anniversary dates
- 9 Era summer fashions—1930's
- 10 MAFFI Minute
- 10 SCR6 car show info
- 11 Our advertising friends
- 12 Officer List & Mailing Info



A Note from
Harbor President
Dennis Simpson



The Second Gear Grind

OK, I have been called a lot of things in my life but I guarantee one of them is not "Artist". But this last month I had the opportunity to join other HAMARC members at a Water Color Seminar hosted by Fran Earhart at the Gordinier's home. There were lots of laughs and socializing besides Fran's instructions and the painting. If you were not there, I think you really missed a good one. Thank you again, Fran! We really appreciated your shared knowledge of the Art and stories of your heritage and meeting of Greg.

Members that don't take advantage of these seminars, arranged by our Activities Committee, are missing out on some of the benefits membership in the Harbor Area Model A Club has to offer.

If you are looking for something different to do on a Saturday afternoon, come and join us for one of these "Special Events".

Till next time, remember, your only failures come when you never try.

Dennis



**Editor's Corner
By Dick Wyckoff**



Our activity committee has outdone itself again this last month. Lots of fun events involving family, friends and (of course) Model A's. Museums, tours, (food), meetings, art projects, car shows, an anniversary picnic (more food) . . . WOW!

The best thing is being with our friends and sharing stories.

Dennis, Dr. Steve and I participated in the El Segundo car show last weekend along with 300+ other fine cars. It is amazing how many people enjoyed our cars and took lots of pictures. I think there was an estimated 10,000 people that attended.



Several of us attend the weekly Friday afternoon car show at the old Ruby's parking lot in Redondo Beach. Again, lots of interesting cars show up. The fun thing is that each car has it's own unique story.

See you at the next event!

Dick

HARBOR MARC/MAFCA BUSINESS MEETING

DATE: July 26, LOCATION: Walteria Park Club House

PRESIDENT: Dennis Simpson called the meeting to order at 7:30P.M.

SALUTE TO THE FLAG: Jack Gordinier led the flag salute.

RECOGNITION OF PAST PRESIDENTS : Drain Marshall, Dick Wyckoff and Tim Harrison.

MINUTES OF PREVIOUS MEETING: Dennis asked for a motion to accept the minutes as appeared in the Harbor Light. Tim made the motion to approve the minutes. Dick W. second the motion. All were in favor.

PRESIDENT: Dennis Simpson Thanked Linda Simpson for hosting the continental breakfast for club members, before going to the Relay for Life car show. Dennis recognized the August birthdays and anniversaries.

VICE-PRESIDENT: Tim Harrison reported had Andy Soto introduce his friend attending the meeting tonight. Andy introduced Jerry Wright.

TREASURER: Daffy Wagner reported a balance of [REDACTED] We have outstanding bills to be paid. Tim is recycling bottles and cans.

HARBOR LIGHT EDITOR: Dick Wyckoff reported the El Segundo car show is August 17. Let Dick know of upcoming events and items for sale.

TECHNICAL DIRECTOR: Cliff Le Fall - Absent. Dennis reported Al's Garage will be closed for the next two Saturday's due to repair on the door.

TOUR DIRECTOR: Open Position-Donnis Bates chairman for the Activities Committee reported.

July 27—Lions Automobilia Museum tour. Meet at Harbor Freight at 9:15AM, leave at 9:30AM.

August 10—Water Colors by Fran Earhart at the Gordinier's at 1:00PM, \$10.00 per person.

August 17—El Segundo Car Show, contact Dick Wyckoff.

August 18—Club Picnic at Lomita Park at 10AM.

Sept. 14—International Model A Ford Day tour to Pointe Vicente. Meet at the Simpson's at 10AM. Bring your picnic lunch

Sept. 22 – Point Fermin Tour

Oct. 19 – Honda Museum Tour

Oct. 26th – Redondo Union High School Car Show, Trunk or Treat \$20 entry fee

HISTORIAN: Janet Winter hoped everyone enjoyed her article in the Harbor Light

TOOLS: Bob DeCrescenzo was absent

MEMBERSHIP: Ursi Schmidt thanked Andy for bringing a visitor.

SUNSHINE: Theresa LeFall was absent. Dennis reported that Rob Hernandez's mother passed away.

WEBMASTER: Steve Thompson—Absent.

ADVERTISING: Jim Huizdos—everything okay.

MERCHANDISE: Jim Huizdos— New shirts and hats available.

REFRESHMENTS: Weeg Thompson—Absent. Simpson's & Harrison's provided the refreshments tonight.

OLD/ON GOING BUSINESS: None.

NEW BUSINESS: None.

NEXT BUSINESS MEETING: August 18th, 2024, At the picnic.

NEXT BOARD MEETING: August 10th, 2024, Al's Garage.

MEETING ADJOURNED: 8:05 P.M., Raffle followed.

RESPECTFULLY SUBMITTED: Gloria Younkin, Secretary

August meeting was held at the Club's picnic

Good morning Harbor Area Model A Club and guests,
Welcome to our 67th Annual Picnic. We have all kinds of activities and fun planned for you. Thank you to those that brought out your Model As today. And thank you once again to Donnis and the Activities Committee for all you do for the Club. I'm not going to bore you with all the Club Business stuff, I am going to reserve that for your Vice President, Tim. . . .

Dennis Simpson, president



[Saturday Morning Coffee Gathering is Alive and Well!](#)

If you are looking for a little tire-kicking adventure on **Saturday** mornings between 7 and 9AM, check out the Caffeine Cruisers at the corner of Artesia Blvd. and Hawthorne, in Torrance, CA. Several of the Harbor Model A club members and other car enthusiasts of all car types meet to talk cars. There are some very nice autos and some nice people there, too!

The address is 17400 Hawthorne Blvd., Torrance CA. (at Artesia Blvd.)

Come on by and get your weekend started in true So. California style.



[2024 Membership, Roster and Club Merchandise Items](#)

Jim Huizdos has a selection of new **Club merchandise**. We have hats, shirts, patches, t-shirts and we still have 60th anniversary items for sale at a discount. More to come. The updated **2024 Harbor phonebooks/rosters** are available from Ursi free of charge through e-mail. Club members that don't attend events can request a phonebook/roster by mail. Contact **Ursi Schmidt** at 310-561-4895. Make sure Ursi has your latest info. **Just a note:** We regularly update the roster. If you have any address changes, phone number changes or email changes, let Ursi know. Let Dick Wyckoff know, too. He'll put the info in the *Harbor Light*.



The local Manhattan Beach pier (circa 1940?)

Club's tour to the Lion's Car Museum







On July 27, Club members met to take our Club's private tour of Lion's Automotive Museum. We had 10 Model A's which all putted right along and 3 moderns with a total of 32 members joining in the excursion. Club members attending were divided into two groups each led by a docent. What an amazing collection of vintage/collectible automobiles. One of the best collections of Willys around and, of course, several racers. The murals were beautiful and made you feel as if you were in the location appropriate to each car. As an added bonus (only available to our group), we got to see the behind the scene restoration areas and the vehicles waiting for the restorers' magic touch.

No Harbor Area Model A tour would be without food. As promised, we had a yummy box lunch in the Lion's 50's diner. The perfect ending to a perfect day.

Pat Harrison



September 2024 Calendar of Events

SEPTEMBER 2024			HARBOR A HAPPENINGS			
SUNDAY	MONDAY	TUESDAY	WEDNESDAY	THURSDAY	FRIDAY	SATURDAY
1	LABOR DAY 2  DINNER 4:30 *Location TBD	3	4  ACTIVITY COMM. MTG. 11 am	5	6	7 BOARD MEETING 9:30 Al's Garage  MODEL A TECHNICAL SUPPORT Al's Garage 9:30-12
8	9 DINNER 4:30 *Location TBD	10	11	12	13	14  INTERNATIONAL MODEL A FORD DAY Meet at Simpson's @10
15	16 DINNER 4:30 *Location TBD	17	18	19	20	21 MODEL A TECHNICAL SUPPORT Al's Garage 9:30-12
22  POINT FERMIN LIGHTHOUSE See info below	23 DINNER 4:30 *Location TBD	24	25	26	27  MODEL A CLUB MEETING Walteria Club House 7:30 PM Food for Kids bags distributed	28 MODEL A TECHNICAL SUPPORT Al's Garage 9:30-12
29	30 DINNER 4:30 *Location TBD					*Contact Jim Huizdos or Gloria Younkin for dinner location.

SEPTEMBER EVENTS – ADDITIONAL INFORMATION

Saturday, September 14th, INTERNATIONAL MODEL A FORD DAY
 Location: Drive along waterfront in our Model A's
 Meeting Location: The Simpson's, 2402 Burrirt Ave., Redondo Beach, 90278
 Time: 10:00am
 Cost: None
 Lunch: We will be eating picnic style at our destination.
 Bring: Your lunch, chairs and/or a blanket (in case you want to nap on the grass).
 Note: We will be having a photo opportunity for the International Model A Ford Day newspaper article in the Model A News. Drive your Model A. (Moderns are welcome too)

Sunday, September 22nd, POINT FERMIN LIGHTHOUSE
 Location: 807 W. Paseo Del Mar, San Pedro, 90731
 Time: 12:00 Noon
 Cost: None
 Meeting Time: 10:45am leave at 11:00am
 Meeting Location: Walteria Club House, 3855 W. 242nd street, Torrance, 90505
 This event will include a private tour before the Lighthouse opens to the general public at 1:00pm. Parking will be inside the white picket fence for up to 10 cars. If we have more than 10 A's, they will be parking on the grass outside the white picket fence.
 Lunch: TBD – We will be enjoying lunch together at a yet to be determined destination. Lunch, of course, is optional but . . . as we always say 'you gotta eat'



Friday, October 25th, Club meeting, Potluck, and Food for Kids donation bags collected!
Saturday, October 26th, Redondo Beach Union High School Classic Car Show

- Show our cars!
- Trunk or Treat too!

CHECK BACK HERE NEXT MONTH FOR GREAT EVENTS THAT ARE IN THE WORKS FOR NOVEMBER AND DECEMBER.

Picnic celebrating club's 67 years August 18, 2024



The Winners

Tech Tip

Submitted by Ted Kuchta

Removal of front spring perches

The front spring perches mounted in the front axle can be a very stubborn part to remove and a method that works very well is to make a press using some Model A parts. It involves using the two front spring U bolts (part # A5455B) and the front spring center lower plate (part # A5458). Remove the nut that fastens the perch in place. Place a U bolt on the axle on each side of the front wishbone and position the dimple in the spring plate over the threaded part of the spring perch. The U bolt must have good threads because this will require a lot of force and rusted or pitted threads will strip easily before the perch budes from its resting place. Non castle type nuts are recommended because they provide more thread coverage and load bearing ability. Tighten the four nuts on the U bolts uniformly. This applies pressure to push the perch out of the axle. If this does not move the perch, heat may be needed to help loosen the bond of rust. This procedure works well even when the front axle is still on the car.

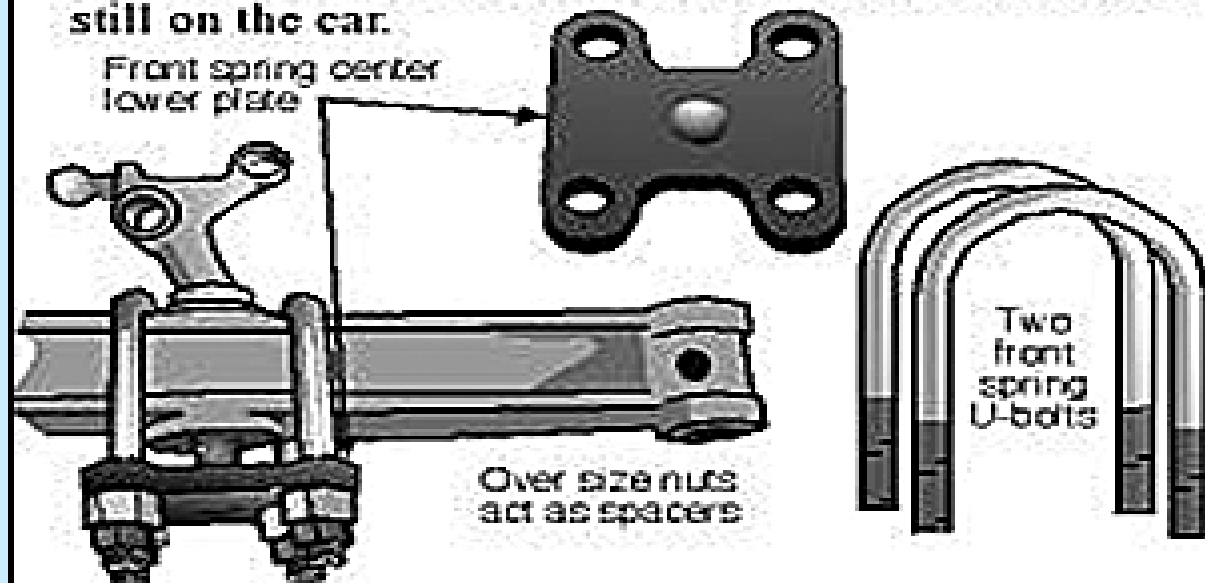

September Birthdays

September Anniversaries

5 Dennis Simpson
 6 Darlene Funk
 6 Jim Beardsley
 8 Bob Olsen
 8 Rob Hernandez
 11 Ursula Schmidt
 14 Cliff LeFall
 17 Art Wagner

6 Danny & Nicole Schmitz
 17 Dick & Gwen Valot



1930 Era Fashions

MARC OF FASHION MEN'S HATS

By Esther Meyer



Men's hat styles remained the same through the four years of the Model "A" era. There were hats for every occasion, from the most casual golf style hat to go with knickers, to the top hat with formal evening tails. Straw hats for summer were worn with Palm Beach suits. Derbys or fedoras were worn with business suits. For every job there was a work hat. Following are descriptions and examples of men's hats which were used during the Model "A" era.



All Wool:
 Hand shaped and hand blocked of fine all wool top coating material. One piece top with warm inband for cold weather. Fancy medium brown plaid and fancy medium gray plaid.

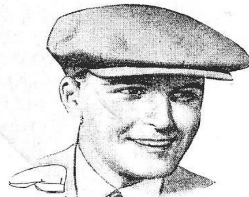

All Wool One-Piece Kersey

One Piece Kersey:
 Solid one piece style all wool kersey cloth, satin lined with warm inband and unbreakable visor. Colors: bluish gray and tan.



All Wool:
 All wool with a soft nap closely resembles camels hair. Patterns are dressy and refined. Satin lined. Colors: medium gray and medium tan.



Wool and Silk:
 About 2/3 wool, balance silk. Full cotton twill lined. Colors: gray and brown.

New Snappy Collegiate Cap



Collegiate Cap:
 Smaller shape 3/4 wool, balance rayon. All around leather sweatband. No inband. Colors: fancy grey and tan.



Adjustable:
 Adjust the buckle in front to fit head. Tailored of a swaggar plaid material 2/3 wool. Genuine leather sweatband in front, satin lined. Colors: fancy bluish gray plaid, fancy tan plaid.

MAFFI Minute

Model A Enthusiasts:

Today, August 19, 2024. the site at the Model A Museum was prepared for the expansion construction to begin! How exciting!! The expansion will allow for more cars to be displayed and stored, more vignettes to be displayed showing era scenes, a garage where cars can be worked on AND where education can take place for maintenance/overhauls of the Model A. There will be a restroom in the building with the expansion as well, which may not be as exciting, but certainly will be appreciated!

Many Model A enthusiasts have contributed to this expansion. We have cash donors, donors who have given Model A cars to be sold, Model A enthusiasts who have purchased Sweepstakes tickets to help out, others have purchased a plaque with their car and name on it to go on the wall as a way of helping. There's also many people to thank behind the scenes too; those gave hours of time getting the donated Model A's for sale running well is just one example. It takes a whole lot of Model A'ers to make a museum this great, and we thank you and love you for it.

Although the expansion is officially underway, we can't stop now! There is a whole new piece of real estate to outfit to tell the story of the Model A and its place in history, so we will continue to fundraise until all the pieces are in place. Thank you for whatever you have done and can do to help the Model A Ford Foundation Inc. Museum be the best.

Cindy Ellenbecker

MAFFI Trustee, Secretary



SOUTHERN CALIFORNIA REGIONAL GROUP (SCRG)

WE WILL LEND OUR SUPPORT TO RIVERSIDE'S
ORANGE BLOSSOM A'S MODEL A FORD CLUB

ON ITS FUNDRAISING, 3RD ANNUAL VINTAGE CAR SHOW

Saturday, Oct 26, 2024 at Elks Lodge, 6166 Brockton Ave. Riverside, CA.

To encourage you to drive and enter your cars, the SCRG will hold an opportunity drawing for FIVE \$50 GAS CARDS. ONLY MODEL A'S THAT PARTICIPATE IN THE CAR SHOW WILL BE ELIGIBLE. The number of tickets you receive depends on how far you live from the Elks Lodge in Riverside.

- 1 ticket for 1 to 15 miles distance
- 2 tickets for 16 to 30 miles
- 3 tickets for 31 to 45 miles
- 4 tickets for 46 to 60 miles
- 5 tickets for 61 or more miles.

(You can only win once, and must be in attendance to win.)

SCRG 2558 Arroyo Canyon Rd. Escondido, CA 92025 secretary@scrgmafca.com

The *Harbor Light* is a monthly publication for the Harbor Area MARC/MAFCA. All articles or want ads must be received by the 15th of each month in order to appear in the following month's publication. Neither the *Harbor Light* and its staff, nor the Harbor Region of the Model A Restorer's Club Inc. and Model A Ford Club of America, Inc. will assume any liability for errors or omissions, or for any liability or resultant damages for products, opinions or services listed herein. Some information contained in our newsletter has been reprinted from other newsletters; we thank and acknowledge them. Editor



Harbor Area Model A Club

 Torrance, California



Torrance, CA
JOEY'S SMOKIN' BBQ
www.getmesomebbq.com

25308 Crenshaw Blvd.
 Torrance, CA 90505
 Email: joeyssmokinbbq@outlook.com
 1-310-257-1324

Proud printer of the 'Harbor Light'
STUDIO PRINTING

Edward Su
 ed@studioprinting.net
www.studioprinting.net
 1750 E. Holly Avenue
 El Segundo, CA 90245
 PHONE: 310-333-8989
 FAX: 310-333-8986
 CELL: 310-292-3219

EARLY FORD STORE
 of California
www.earlyfordstore.com

Specializing in Rare Parts and Accessories for Early Fords 1928/1972 Passenger Car & Pick-Up
Bill McGrath
 San Dimas, CA 91773
 108 W. Bonita Ave.
 Tel: (909) 305-1955
 Fax: (909) 305-1953



Mike's "A" Ford-able Parts
Mike Butcher
 124 Model A Drive, Maysville, GA 30558
 email: mike@mikes-afordable.com - www.mikes-afordable.com
 Fax: 706 652 2492 - Phone: 706 652 3866
 1 888 TRY MIKE (879 6453)

 Specialising in 1928 - 1931 Model A Ford Parts

M B RENTALS
 Studio Equipment
 Lights and Fixtures

Drain Marshall
 Home: (310) 378-5061
 Cell: (310) 570-5938

BRATTONS ANTIQUE AUTO PARTS

 1606 BACK ACRE CIRCLE
 MOUNT AIRY, MD 21771
 Order # **800 255-1929**
 Web: brattons.com
 FREE 194 page illustrated MODEL A parts catalog
 Catalog contains 3,200 Model A parts with full descriptions and Picture of each part.
 Supplying Quality by using over 90% U.S. parts
 Serving the Model A restorer with parts since 1977

TORRANCE TRANSMISSION
 HONESTY EST. 1976 INTEGRITY
 ERIC BAILEY
 310-378-9217
TORRANCETRANSMISSIONSERVICE.COM
 24009 HAWTHORNE BLVD.
 TORRANCE, CA. 90505
torrancetrans@gmail.com

ARIZONA MODEL A, L.L.C.
 • NEW PARTS
 • USED PARTS
 • SERVICE
 • RESTORATION
 • HOURS: TUES-FRI 9-12, 1-5
 SAT & EVES BY APPOINTMENT

 SAMUEL P. GUTHRIE
 15838 S. GILBERT RD., CHANDLER, AZ 85225
 (480) 782-0266

Bringing midwest values and integrity to Southern California for over 30 years

Midwest Roofing Co., Inc.
BILL YOUNKIN
 1305 W. 132nd Street
 Gardena, CA 90247
 Cell (310) 766-6922

Our Advertising Friends

<p>CW Moss Ford Parts 420 W. Chapman Ave. Orange, CA 92866 1-800-322-1932</p>	<p>Aquarium of the Pacific 100 Aquarium Way Long Beach, CA 90802 1-562-590-3100</p>	<p>Snyder's Antique Auto 12925 Woodworth Rd. New Springfield, OH 44443 1-888-262-5712</p>
---	---	---

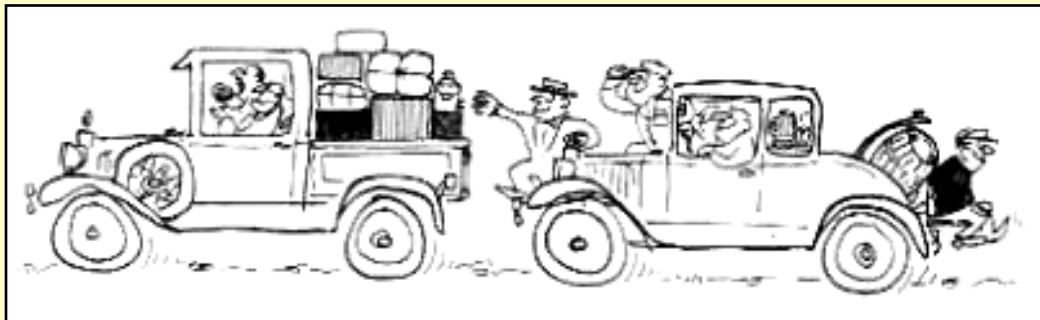



For MARC info and membership, see www.ModelARestorers.org



For MAFA info and membership, see www.MAFA.com

The Harbor Area A's meet monthly on the last Friday of every month at the Waleria Park Clubhouse, located at 3855 W. 1242nd St. in Torrance, California. Meetings begin at 7:30 PM (The park is located about 1-1/2 blocks west of Hawthorne Blvd. and one block south of Pacific Coast Hwy.) We'd like to invite all interested parties, even if they don't own a Model A Ford, to come and join us. Our goal is to educate the public about Model A Fords and have fun while doing it.

2024 Board of Directors:

President:

Dennis Simpson (310) 343-8227
Email: OldFordor@gmail.com

Vice-President:

Tim Harrison (310) 920-3319

Treasurer:

Daffy Wagner (310) 374-6113

Secretary:

Gloria Younkin (310) 316-8722

Activities Committee:

OPEN

Technical Director/Safety:

Cliff LeFall (323) 715-3153

Appointed Officers:

Membership:

Ursula Schmidt (310) 561-4895

Historian:

Janet Winter (310) 251-6673

Sunshine Secretary:

Theresa LeFall (323) 715-3153

Advertising:

Jim Huizdos (310) 375-2737

Refreshments Coordinator:

Weeg Thompson (310) 346-6409

Regional Correspondent:

Sue Hankins (310) 357-5233

Web: HarborAreaModelAClub.com

Appointed Officers:

Tool Custodian:

Bob De Crescenzo (310) 540-3690

Merchandise:

Jim Huizdos (310) 375-2737

M/Sergeant-at-Arms:

Jack Gordinier (424) 263-2397

Webmaster:

Steve Thompson (310) 346-6143

Harbor Light editor:

Dick Wyckoff

Phone: (310) 322-8863 (h)

(310) 779-5772 (c)

E-mail: JannDick@earthlink.net

The first Harbor Light
September 1961

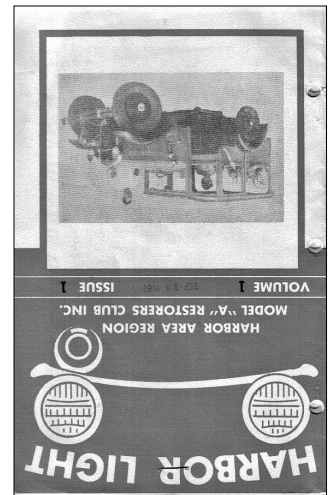

From:
Harbor Area Model A Club
Dick Wyckoff, Editor
337 Lomita St.
El Segundo CA 90245

SEPTEMBER 2024

The Harbor Light

